

# SLIM SLAB TABLE HD

US PATENTS PENDING

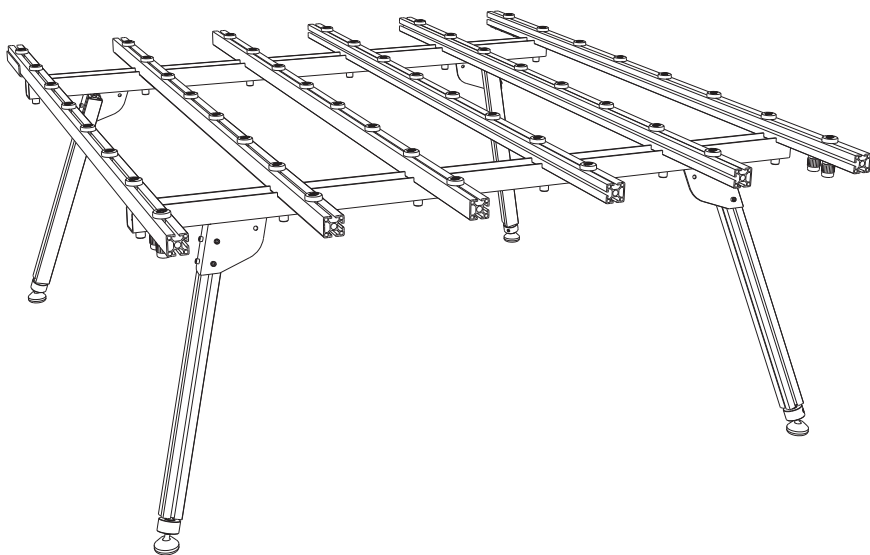

en

fr

es

Slim Slab Table HD User Guide: 200707

Part #: SST-HD-20

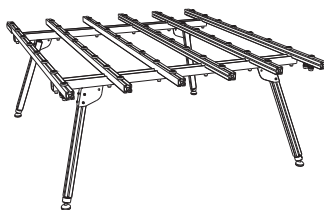

 **MADE IN THE USA**—FROM  
US AND IMPORTED PARTS

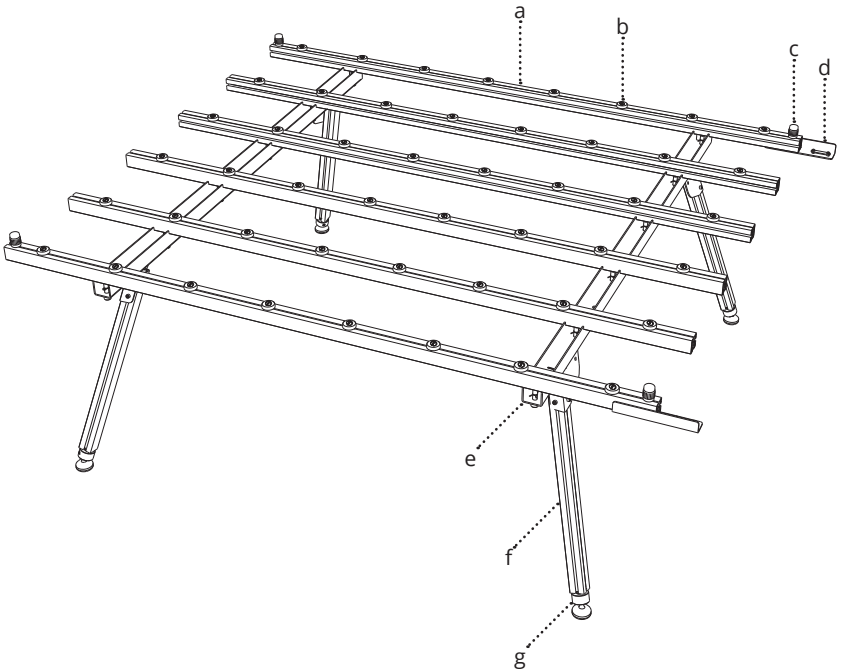

- a. Support Rail
- b. Material Support Puck
- c. Material Stop Post
- d. Table Connector
- e. Leg Bracket
- f. Leg
- g. Leveling Foot



# SAFETY

en

Failure to follow Safety, Maintenance, and Instructions may result in product failure, serious injury, and/or property damage.

## Caution

- **Observe weight limit:** 600 pounds (272 kg)
- **Distribute weight evenly.**
- **Ensure parts are assembled securely.**



# MAINTENANCE

- Clean with water, mild detergent, or compressed air.
- Lubricate leveling foot screw threads with white lithium grease.
- Replace worn or damaged parts as needed.

# INSTRUCTIONS



en



1. Lay out the rails and leg brackets upside down as pictured.
2. Align the leg brackets and use the include  $3/16''$  hex key to fasten the captured screws to the rails.
3. Loosen the leg bracket screws, slide the legs onto T-nuts and tighten the screws.
4. Turn the table upright.
5. Store the hex key in the leg bracket.
6. Use the leveling feet to level the table.
7. Install the material support pucks where needed.
8. Remove the material stop posts from their stored position and install where needed.
9. Optionally, use the table connectors to connect two tables as pictured.

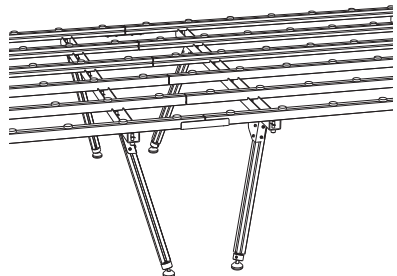
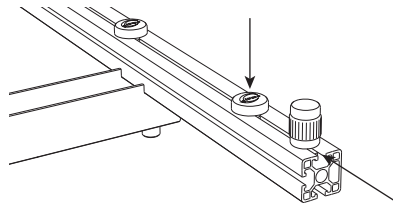
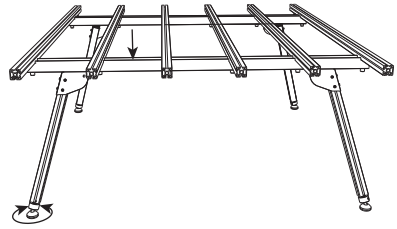
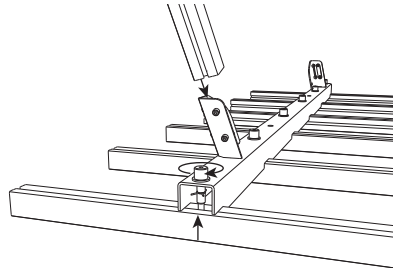



# SÉCURITÉ

fr

Le non-respect des règles de sécurité et d'entretien ainsi que des instructions peut provoquer une défaillance du produit, une blessure grave, et/ou un dommage de propriété.

## Avertissement

- **Respecter la limite de poids** : 600 livres (272 kg)
- **Distribuer le poids uniformément.**
- **Vérifier que toutes les pièces sont assemblées solidement.**



# ENTRETIEN

- Nettoyer avec de l'eau, un détergent doux, ou de l'air comprimé.
- Lubrifier le filetage des pieds de nivelage avec de la graisse blanche au lithium.
- Remplacer des pièces usées ou endommagées au besoin.

# INSTRUCTIONS



fr



1. Placer les rails et les supports de pattes à l'envers comme dans l'illustration.
2. Aligner les supports de pattes et utiliser une clé hexagonale de 3/16" pour attacher les vis imperdables aux rails.
3. Desserrer les supports de pattes, glisser les pattes sur les écrous à griffes et serrer les vis.
4. Retourner la table.
5. Ranger la clé hexagonale dans le support de patte.
6. Utiliser les pieds de nivelage pour niveler la table.
7. Installer les supports en rondelle là où nécessaire.
8. Enlever les tiges d'arrêt de leur position de rangement et les installer là où nécessaire.
9. Vous avez l'option d'utiliser les connecteurs de tables pour joindre les deux tables comme illustré.

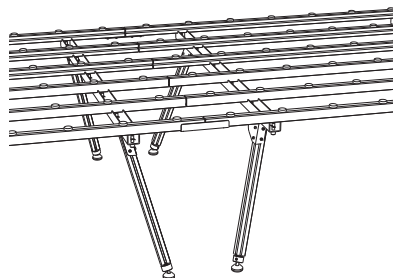
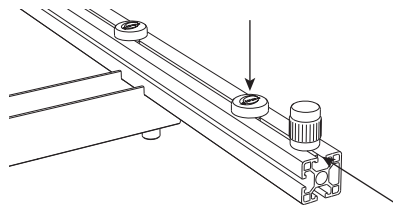
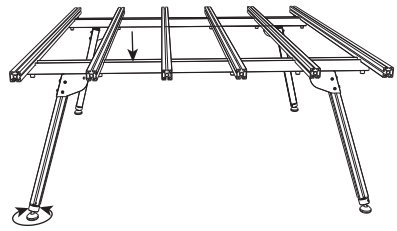
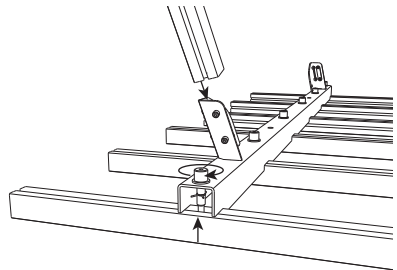



# SEGURIDAD

es

El incumplimiento de las instrucciones de seguridad, mantenimiento y de las instrucciones del producto puede provocar la falla del producto, lesiones graves y / o daños a la propiedad.

## Precaucion

- **Observar el límite de peso:** 600 libras (272 kilos)
- **Distribuir el peso de manera uniforme.**
- **Asegúrese de que las piezas estén ensambladas de forma segura.**



# MANTENIMIENTO

- Limpiar con agua, detergente suave o aire comprimido.
- Lubrique las roscas de los tornillos niveladores del pie con grasa de litio blanca.
- Reemplace las piezas desgastadas o dañadas según sea necesario.



# INSTRUCCIONES



es

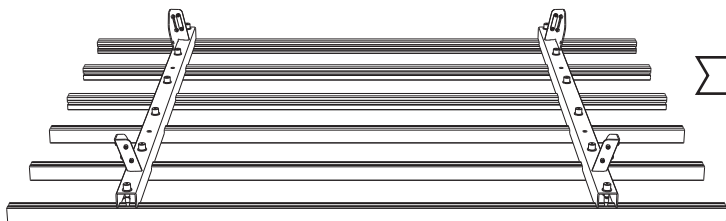

1. Coloque los rieles y los soportes (o abrazaderas) boca abajo como se muestra en la imagen.
2. Alinear los soportes (o abrazaderas) y use la llave hexagonal de 3/16 pulgadas para sujetar los tornillos capturados a los rieles.
3. Afloje los tornillos de los soportes (o abrazaderas), deslice las patas sobre las tuercas en T y apriete los tornillos.
4. Coloque la mesa en posición vertical.
5. Guarde la llave hexagonal en el soporte (o abrazadera).
6. Use los pies niveladores para nivelar la mesa.
7. Instale los discos de soporte de material donde sea necesario.
8. Retire los postes de detención de material de su posición almacenada y instalelos donde sea necesario.
9. Opcionalmente, use los conectores de mesa para conectar dos mesas como se muestra en la imagen.

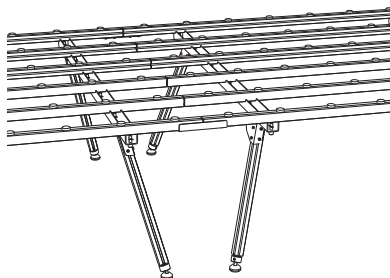
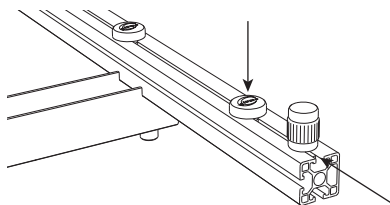
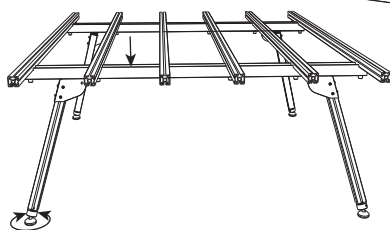
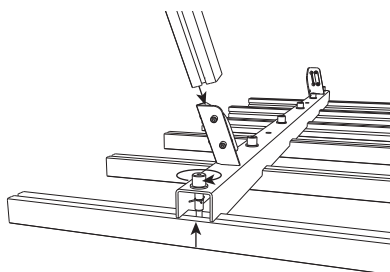



## RELATED PRODUCTS

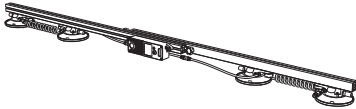

The **Sink Hole Saver™** Auto is a surface-mounted, vacuum-pump powered reinforcement system that strengthens fragile materials during lifting, transportation, and installation. This product features proprietary, non-marking, concaved vacuum cups with triple sealing rings for a strong, reliable hold—even on textured and leathered surfaces.

Part #: SHS-SA-20

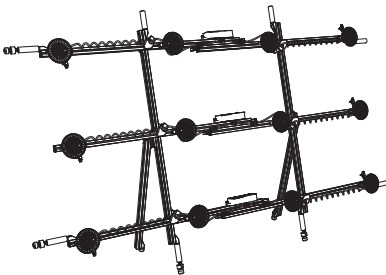

The **S3 Slim Slab Saver™** is a versatile, completely customizable rigid frame and reinforcement system that reduces strain and risk of injury while handling large format slabs and other fragile materials.

Part #: S3-3A-19

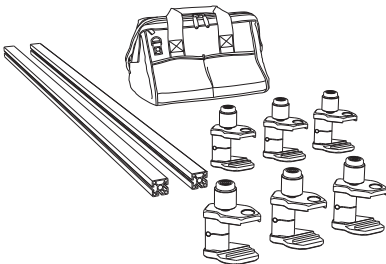

The **5' Rigid Cross-Brace Kit** includes two 59" rails and six clamps. Use the kit in combination with two or three Sink Hole Saver™ or Slim Slab Saver™ rails to create a frame.

Part #: RCB-L6-19

# INFORMATION



## Customer Service

We're here to help you! If you have any questions, concerns, or parts and service needs, please contact us directly.

USA: 877-311-1976  
[omnicubed.com/help](https://omnicubed.com/help)

Europe: +0044 (0)1482 935 570  
[omnicubedeurope.com](https://omnicubedeurope.com)

All Other Regions: +1-530-748-3120  
[customerservice@omnicubed.com](mailto:customerservice@omnicubed.com)

## Warranty

For a description of the Omni Cubed® warranty, please visit [omnicubed.com](https://omnicubed.com).

## Liability

Omni Cubed, Inc., its affiliates, authorized distributors, officers, directors, agents, employees, or manufacturers shall not be liable for any direct, indirect, punitive, incidental, or special consequential damages, to property or life, whatsoever arising out of or connected with the use or misuse of our products.



© 2020 Omni Cubed, Inc.  
All rights reserved.

Omni Cubed, Inc.  
3870 Dividend Drive  
Shingle Springs, CA 95682, USA  
Tel: 877.311.1976  
[omnicubed.com](http://omnicubed.com)